

MONDO 3

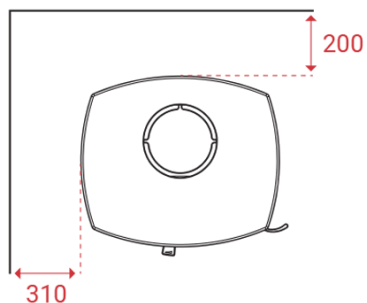

Peso 112 kg

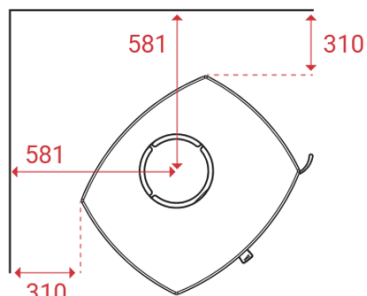
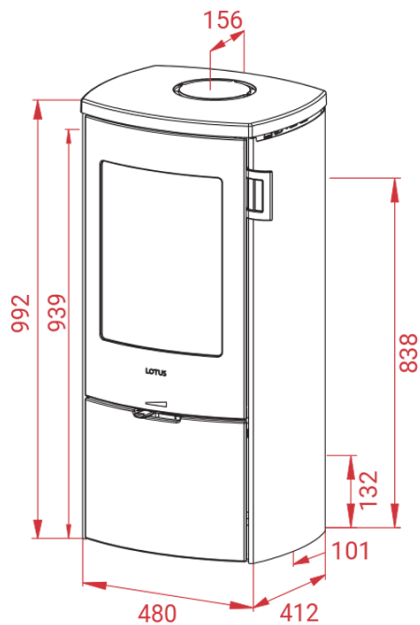

Area riscaldata
30-120 mq



Depressione fumi
12 Pa



Polveri sottili
20 mg/m³



Potenza nominale
5 kW



Consumo orario
1,5 kg



Potenza di esercizio
3- 7kW



Rendimento
79%